

CUSTOMER NAME : 0157

## SPECIFICATION FOR APPROVAL

ITEM :	DC Voltage Stabilized Supply	
MODEL NO. :	ADS-12FG-12N 12012EPB	
SAMPLE CODE:	0157FG12V1AEPB	REV.: A1
Honor P/N :		No.:
CUSTOMER CODE_NO. :	101701323	

### CUSTOMER'S APPROVED

Please send one copy of this specification back after you signed approval for production pre-arrangement.

Approved By : \_\_\_\_\_  
 Date : \_\_\_\_\_

Drawing	Agreement				Approver
	Product Eng.	Mechanical	PM	Check	
赵杨华	孔兵	刘志华	李燕	林李炎	郝留全
Nov.14.2018	Nov.14.2018	Nov.14.2018	Nov.14.2018	Nov.14.2018	Nov.14.2018

**SHENZHEN HONOR ELECTRONIC CO.,LTD**
**Address: No. A、B、C Building, Xinghui Industrial Park, Gushu No. 2Rd,  
 Xixiang, Baoan District, Shenzhen**
**Telephone:86-755-3385-7182**
**Telefax: +86-755-81453432**
**Http://www.honor-cn.com**

## Table Of Contents

	Page
<b>1. Revision History.....</b>	<b>5-7</b>
<b>2. Electrical Specification .....</b>	<b>8~15</b>
2-1. General Specification.....	9
2-2. Electrical Requirements.....	9
<b>2-2-1.Input Voltage.....</b>	<b>9</b>
2-2-1-1. Input Voltages.....	9
2-2-1-2. Inrush Current(Cold Start).....	9
2-2-1-3. Input Fuse.....	9
2-2-1-4. Input Current.....	9
2-2-1-5. Frequency.....	9
2-2-1-6. Efficiency.....	9
2-2-1-7. Primary Over Current Protection.....	9
2-2-1-8. Power loss (Minimum Load Power Consumption).....	10
2-2-1-9. Input Configuration.....	10
<b>2-2-2. Output Requirements.....</b>	<b>10~11</b>
2-2-2-1. Maximum output power.....	10
2-2-2-2. Output Voltage and Current.....	10
2-2-2-3. Output Load Regulation.....	10
2-2-2-4. Ripple and Noise.....	10
2-2-2-5. Line Regulation.....	11
2-2-2-6. Hold up time.....	11
2-2-2-7. Turn On delay time.....	11
2-2-2-8. Rise time.....	11
2-2-2-9. Overshoot .....	11
2-2-2-10. Dynamic Load Response.....	11
<b>2-3. Protection Requirements.....</b>	<b>11</b>
<b>2-3-1. Over current protection.....</b>	<b>11</b>
<b>2-3-2. Short Circuit Protection(Auto recovery).....</b>	<b>11</b>
<b>2-3-3. Over Voltage Protection .....</b>	<b>11</b>

## Table Of Contents

	Page
<b>2-4. Safety and EMC Requirement.....</b>	<b>11~13</b>
2-4-1. Earth Leakage Current.....	11
2-4-2. Hi-Pot tests (Dielectric withstand voltage).....	12
2-4-3. Insulation Resistance.....	12
2-4-4. RFI/EMI/EMS Standards.....	12
2-4-5. EMS Standards.....	12
2-4-5-1. Electrostatic Discharge ESD.....	12
2-4-5-2. Radiated Immunity RS.....	12
2-4-5-3. EFT/AC Line noise.....	12
2-4-5-4. Conducted Radio Frequency.....	13
2-4-5-5. Lightning Surge .....	13
2-4-6. Safety Standards.....	13
2-4-7. EMI.....	13
<b>2-5. Reliability requirement.....</b>	<b>13~14</b>
2-5-1. Mean Time between Failures (MTBF).....	13
2-5-2. E-CAP Lifetime.....	14
2-5-3. Drop Test.....	14
2-5-4. Random vibration test (non-operating).....	14
2-5-5. Hearing Noise.....	14
2-5-6. Hot Burn-In.....	14
<b>2-6. Environment Requirements.....</b>	<b>14~15</b>
2-6-1. Operating temperature.....	14
2-6-2. Operating humidity.....	15
2-6-3. Storage temperature.....	15
2-6-4. Storage humidity.....	15
2-6-5. Operation Altitude.....	15
<b>2-7. Mechanical Features.....</b>	<b>15</b>
2-7-1. Physical size.....	15
2-7-2. AC Input Connector.....	15
2-7-3. Output plug.....	15
2-7-4. LED Light.....	15

## Table Of Contents

	Page
2-7-5. Weight.....	15
2-7-6. Case Color.....	15
<b>3. Circuit Drawing.....</b>	<b>16~17</b>
<b>4.PCB.....</b>	<b>18~19</b>
4-1.TOP SILK.....	19
4-2.BOTTOM SILK.....	19
<b>5.Mechanical Specification.....</b>	<b>20~25</b>
5-1. Case.....	21
5-2. Cable Drawing.....	22
5-3. Label Drawing.....	23
5-4. Barcode Drawing.....	24
5-5. Packing Drawing.....	25

## 1.Revision History



## CHANGE ITEM

Before (Rev.)	After (Rev.)	Change Reason	Remark

## 2. Electrical Specification



## 2-1. General Spec

### Product Description

: This Specification defines the input, output, performance characteristics, environment, noise and safety requirements for power supply.

### Parameter Specification

: Unless specification otherwise, all parameters must meet over the limit of temperature load, and input voltage.

: All measurements shall be taken at  $25^{\circ}\text{C}\pm 5^{\circ}\text{C}$  ambient unless otherwise noted.

## 2-2. Electrical Requirements

### 2-2-1. Input Voltage

#### 2-2-1-1. Input Voltages

Normal voltage: 100 to 240VACrms

Voltage range: 90 to 264VACrms

#### 2-2-1-2. Inrush Current(Cold Start)

No damage at cold or hot start.

#### 2-2-1-3. Input Fuse

The input fuse shall not blow up.

#### 2-2-1-4. Input Current

$\leq 0.3\text{Arms}$  at 100 to 240Vac input and full load.

#### 2-2-1-5. Frequency

Normal Frequency : 50Hz - 60Hz

Frequency range : 47Hz - 63Hz

#### 2-2-1-6. Efficiency

The average efficiency shall not be less than 82.96%(Expressions:[ $0.071*\ln(\text{Pout})-0.0014*\text{Pout}+0.67$ ])

-. According to DoE VI

-. Both 115Vac(60Hz) and 230Vac(50Hz) input voltage condition.

-. Average (25%+50%+75%+100%)/4

-. The DC power supply shall be operated at 100% of nameplate current output for at least 30 minutes immediately prior to conducting

#### 2-2-1-7. Primary Over Current Protection

An adequate internal fuse on the AC input line shall be provided.

**2-2-1-8.Power Loss (Minimum Load Power Consumption )**

CONDITION		RESULT(SPEC)
INPUT VOLTAGE	230VAC	0.10W MAX (INPUT POWER)
OUTPUT VOLTAGE	+ 12.0V / No Load	AT 230Vac/50Hz

**2-2-1-9.Input Configuration**

2 Conductors (Live, Neutral)

**2-2-2.Output Requirements**

**2-2-2-1.Maximum Output Power:** 12 Watts

**2-2-2-2.Output Voltage and Current**

OUTPUT VOLTAGE	MINIMUM VOLTAGE	MAXIMUM VOLTAGE	OUTPUT CURRENT	INPUT VOLTAGE
+12.00Vdc	+11.40Vdc	+12.60Vdc	0.0A~ 1.00A	100Vac-240Vac

table 1

**2-2-2-3.Output Load Regulation**

The output voltage regulation shall meet above table 1, including the effects of line voltage variations, load current, ripple and noise, and the AC component of the load current. The effect of dynamic load changes is not included in this limit.

**2-2-2-4.Ripple and Noise**

A	B
12.0Vdc	0.12Vp-p(120mV)

Column A : Output Voltage.

Column B: Switching Ripple and Noise

Measured methods:

- 1.Performed by 20M Hz bandwidth in oscilloscope.
- 2.Applied 0.1uF high frequency capacitor and 47uF electrolytic capacitor across the end of DC cable.
- 3.Measured at the end of DC cable.
4. tested at 115Vac(60Hz) and 230Vac(50Hz).

**2-2-2-5.Line Regulation** ±2%

Line Regulation= $\Delta V/V_{nor} \times 100\%$

$\Delta V: V_{max}-V_{nor}$  or  $V_{min}-V_{nor}$

Note:  $V_{max}$ :The maximum output voltage when the input voltage changes;

$V_{min}$ :The Minimum output voltage when the input voltage changes;

$V_{nor}$ :Rated output voltage.

**2-2-2-6.Hold Up Time**

10mS min.@115VAC input and full load

20mS min.@230VAC input and full load

**2-2-2-7.Turn On Delay Time**

5S max@ 100Vac to 240Vac input and output Max.Load.

**2-2-2-8.Rise Time**

DC output rise time from 10% to 90% of output voltage shall be less than

30mS max@100Vac to 240Vac input and output Max.Load.

**2-2-2-9.Overshoot**

The output overshoot at turn-on shall not exceed +10%(V) of output voltage at no load and full load connected.

**2-2-2-10.Dynamic Load Response**

Condition:load step from 20% to 80% to 20%,R/S: 0.10A/uS, Transient Response Recovery Time : 30mS.

Result: $\leq 10\%$  (**Dynamic Voltage**)

**2-3. Protection Requirements****2-3-1.Over Current Protection**

1.1A-2.0A @input 100~240Vac 50/60 Hz

**2-3-2.Short Circuit Protection**

The input power shall decrease when the DC output "+" and "-" short, the power supply shall no damage,and shall be self-recovery when the fault condition is removed.

**2-3-3.Over Voltage Protection**

The power supply shall protection when the output over voltage,the power supply shall no damage.

**2-4. Safety and EMC Requirements****2-4-1.Earth Leakage Current.**

0.25mA Max (264V, 50Hz)

**2-4-2.Hi-Pot test**1).Hi-Pot test (Dielectric withstand voltage)-CLASS II 

: leakage(cutoff) current 10mA

: Safety Standard Condition:

Primary To Secondary : 3000Vac ,1 minute for type test

: Mass Production Condition:

Primary To Secondary : 3600Vac ,keeping 2 seconds for production

\* Test methods:Input test voltage beginning from zero to 3600Vac in 0.5s.We move plug after discharge display 0V.

\* Test point : Primary Live and Natural Short ↔ Secondary

2).Hi-Pot test (Dielectric withstand voltage)-CLASS I 

: leakage(cutoff) current 10mA

: Safety Standard Condition:

Primary To GND : 1500Vac ,1 minute for type test

Primary To Secondary : 3000Vac ,1 minute for type test

: Mass Production Condition:

Primary To GND : 1800Vac ,keeping 2 seconds for production

Primary To Secondary : 3600Vac ,keeping 2 seconds for production

\* Test methods:Input test voltage beginning from zero to 3600Vac in 0.5s.We move plug after discharge display 0V.

\* Test point : Primary Live and Natural Short ↔ Ground

**2-4-3.Insulation Resistance**

Insulation resistance shall be more than 100 MΩ at 500Vdc between primary live, primary neutral and secondary.

**2-4-4.RFI/EMI/EMC Standards**

The adapter shall comply with a following RFI/EMI standards when tested in an system configuration.

**2-4-5.EMS Standards**

## 2-4-5-1.EN61000-4-2(IEC61000-4-2:2001 IEC801-2):Electrostatic Discharge ESD

Electrostatic Discharge: ±8KV(Air) ±6KV(Contact)

Judgement Level: ■A B C D

## 2-4-5-2.EN61000-4-3(IEC61000-4-3:2002 IEC801-3):Radiated Immunity RS

Radiated Susceptibility: 3V/m, Class B

2-4-5-3.EN61000-4-4(IEC61000-4-4:1995+A1:2000+ A2:2001 IEC801-4): EFT/AC Line noise.

Transient Test:  $\pm 2\text{KV}$ (EFT)  $\pm 2\text{KV}$ (AC Line noise)

Judgement Level: A B C D

2-4-5-4.EN61000-4-6(IEC61000-4-6:1996+A1:2000)Conducted Radio Frequency

Injected Current Susceptibility: 3Vrms, Class B

2-4-5-5.Lightning Surge

The power supply must satisfy Table's Lightning Surge Spec.

Products	Test Voltage	Test Point & Test Mode	Output Load
Adapter	$\pm 2 \text{ KV}$	Line to Line : C-Mode	Rated Load
	$\pm 4 \text{ KV}$	Line to Gnd : CR-Mode	

Measured methods:

a. Environment Requirements: temperature :15~35°C; humidity :10%~75%RH;

b.Surge voltage is applied to the phase: 0° 90° 180° 270°;

c.Surge voltage is applied: for each polarity voltage of each repeated 5 times, a phase done;  
10 times,each applied voltage interval of 60 seconds.

Judgement Level: A B C D

#### 2-4-6.Safety Standards

The adapter shall be certified with the following safety standards:

	Country	Certified Status	Standard
CE	Europe	Approved	EN60950-1

#### 2-4-7.EMI

Design phase:6dB margin(ClassB) Mass production phase:3dB margin(ClassB)

The adapter linear load test should comply with standard margin, and better suggest to test with end customer's devices for evaluation.

Conducted/Radiated interference: (Power) with Vout grounded or not

### 2-5. Reliability Requirement

#### 2-5-1.Mean Time Between Failures (MTBF)

Output Voltage	Min Voltage	Max Voltage	Current	MTBF	Load Condition
+12.00Vdc	+11.40Vdc	+12.60Vdc	1.00A	100,000Hr	80%

\*Standard: MIL-HDBK-217F;

\*Environment temperature: 25°C

\*Input Voltage: 115Vac & 230Vac

### 2-5-2.E-cap Lifetime

The life estimation of aluminum capacitor must achieve 17,520 hours at 40°C @Full load.

Input voltage: 90V,115V,230V,264V.

Standard: Life Time=Lr \* 2<sup>(To-Tx)/10</sup>

Note-3 CE Capacitor Life time      ΔTo: Self Heat Coefficient (85°C =10, 105°C = 5)

Lr : Capacitor Life Spec                      Ia : Measured Ripple Current

To : Capacitor Temp Spec                      Is : Ripple Current spec

Tx : Capacitor case Temp                      Ff : Frequency Factor

ΔT : Capacitor Self Heat                      Tf : Temperature Factor

### 2-5-3.Drop Test

Unit shall survive drops on all 6 faces from a height of 1m onto hard wood (Total 1 times/face )

No surface crack, function are normal, can be passed dielectric strength and insulation resistance test.

### 2-5-4.Random Vibration Test (non-operating)

Vibrating Amplitude:1.5mm(Max.);Frequency range: from 10Hz to 55Hz, Constant time:10-55-10Hz (1 minute); Direction: vibration X, Y and Z-axis, at least 30 min/axis. Normal performance after test condition is removed.

### 2-5-5.Hearing Noise

The noise generated by the adapter supplied under 100-240Vac of no load and full load shall be lower than 30dBA,measure 5cm from the nameplate.

### 2-5-6.Hot Burn-In

Condition		Result(Spec)
Input Voltage	100Vac / 240Vac	NO Defect, Normal Operating
Output Current	80%~100% load	
Temperature	40°C ± 5°C	
Test Time	4HR ± 1HR	

## 2-6.Environment Requirements

### 2-6-1.Operating Temperature

→ 0°C ~ 40°C

Note: PSU can start-up and work at -30°C @ 0.6A load (Input voltage: 176V-240V)

E-cap lifetime > 1 year at 70°C @ 0.6A load

**2-6-2.Operating Humidity**

→ 10% ~ 90% RH (Condensation : NOT REQUIRED)

**2-6-3.Storage Temperature**

→ -20℃ ~ 70℃

**2-6-4.Storage Humidity**

→ 5% ~ 95% RH (Condensation : NOT REQUIRED)

**2-6-5.Operation Altitude**

→ 0 - 5000m

**2-7. Mechanical Features**

**2-7-1.Physical Size(Unit:mm):** 68.0(L)\*30.5(W)\*41.0(H)

**2-7-2.AC Input Connector:** BS PLUG

**2-7-3.Output Plug**

DC Plug: Straight  $\varnothing$ 5.5×2.1×10mm

DC Cable: 24AWG 2468 1.5M BLACK

**2-7-4.LED Light:** No

**2-7-5.Weight :** About T.B.D.g

**2-7-6.Case Color:** Black

### 3. Circuit Drawing



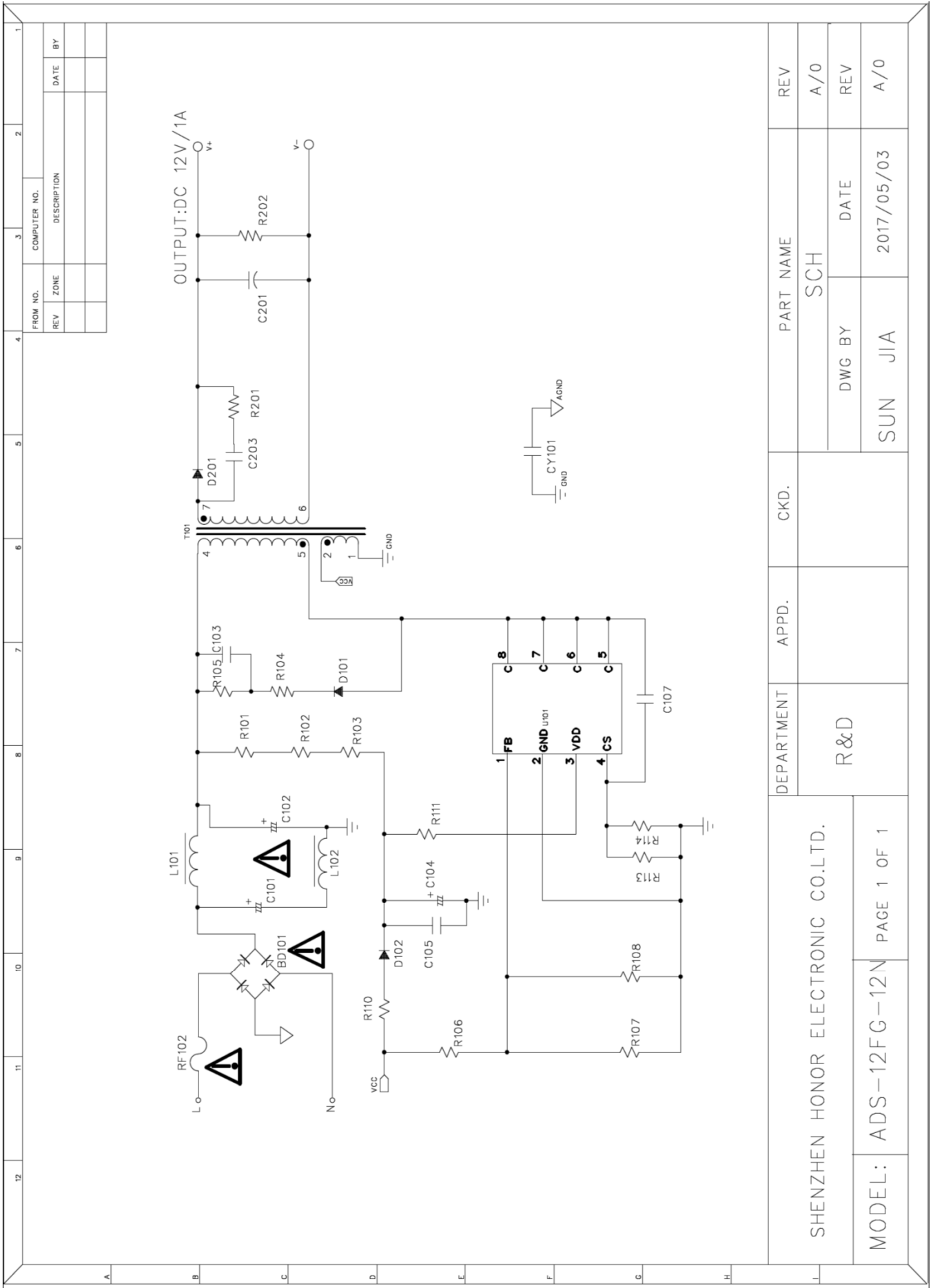

DEPARTMENT	APPD.	CKD.	REV
R&D			A/0
SHENZHEN HONOR ELECTRONIC CO.LTD.	PART NAME	SCH	REV
MODEL: ADS-12FG-12N	DWG BY	DATE	A/0
PAGE 1 OF 1	SUN JIA	2017/05/03	A/0

## 4. PCB Drawing

### TOPSILK

Pictures as below just for reference, according with the latest PCB edition.

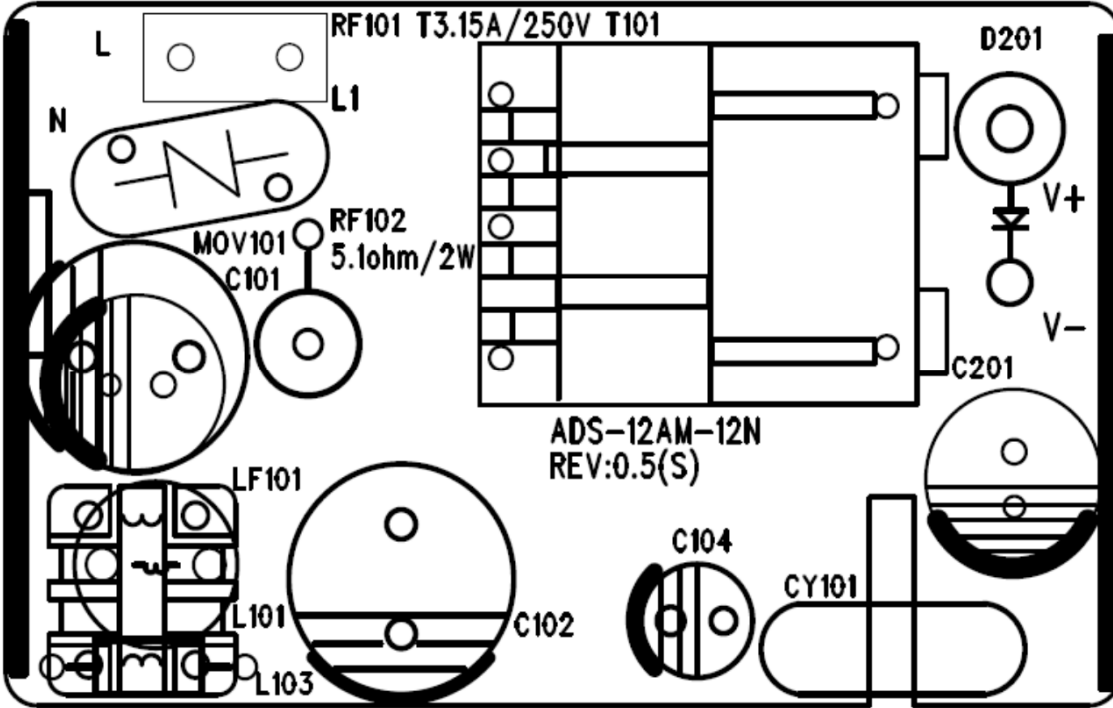

### BOTTSILK

Pictures as below just for reference, according with the latest PCB edition.

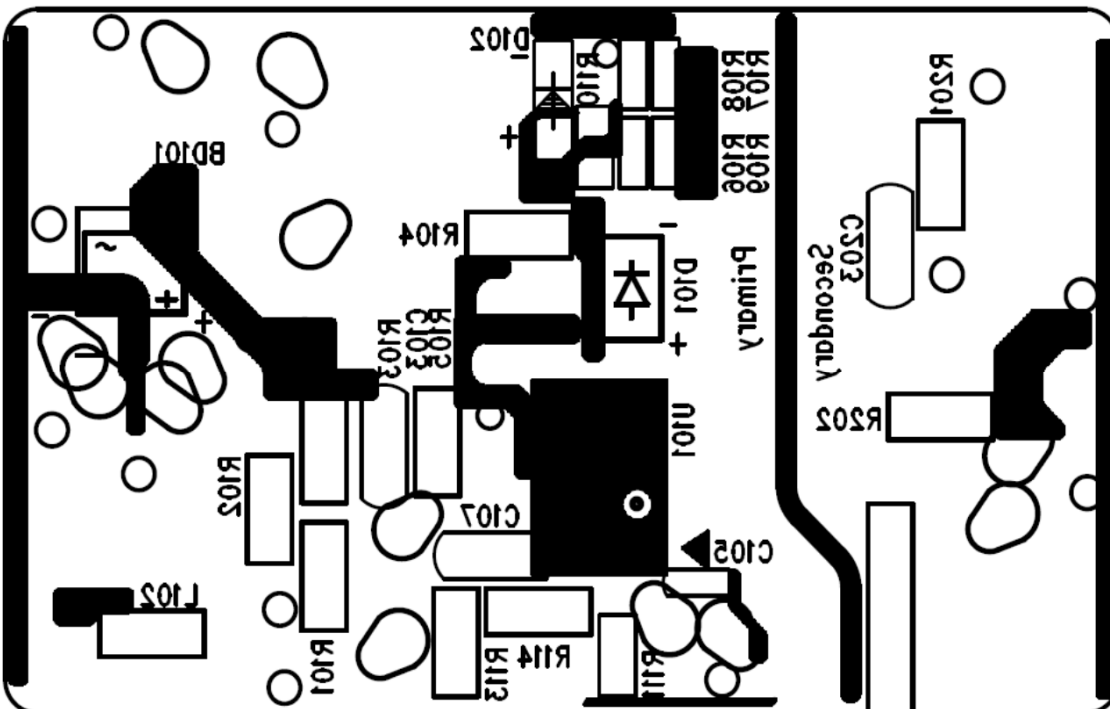

## 5. Mechanical Specification

5-1. Case Drawing

5-2. Cable Drawing

5-3. Label Drawing

5-4. Barcode Drawing

5-5. Packing Drawing

5-1. Case Drawing

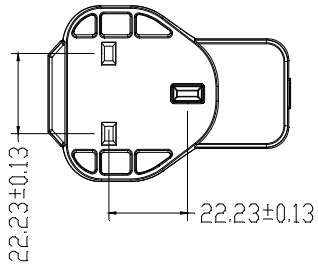
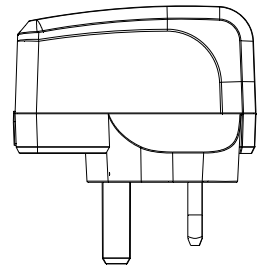
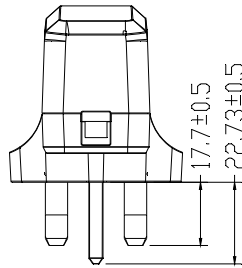
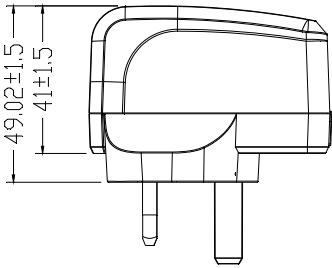
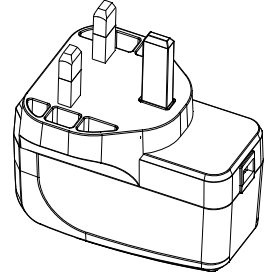
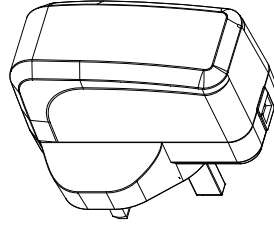
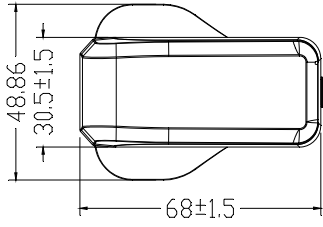

## 5-2. Cable Drawing

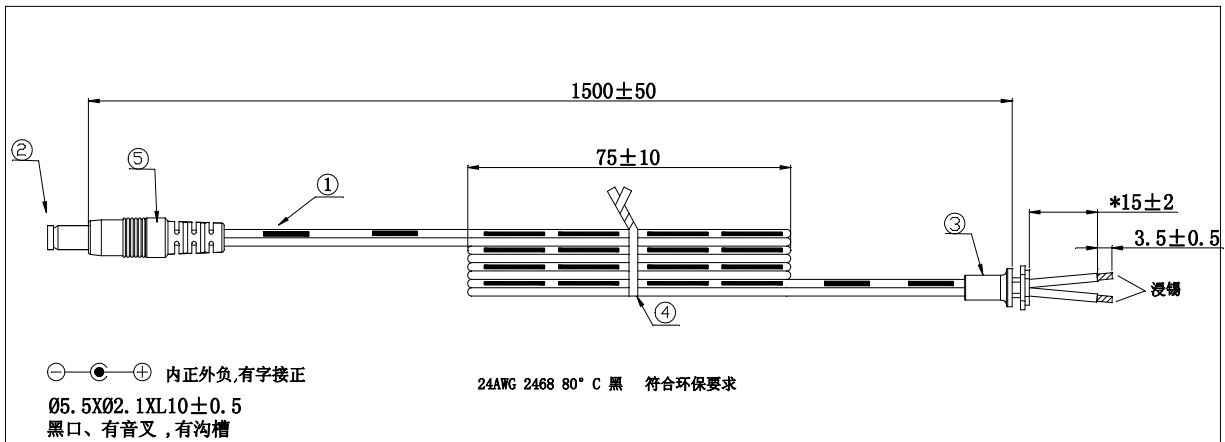
**线材摇摆测试要求:**

线型	摇摆频率	摇摆角度	吊重	次数
24#	40次/分	120°	200±1g	1500次

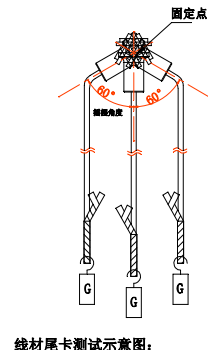
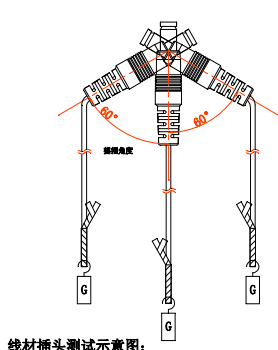
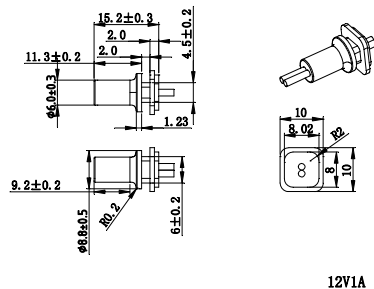
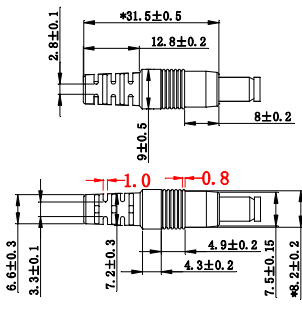

5	胶料	65P PVC黑色低毒 (REACH)	6.0g
4	扎带	单面黑色PET 无芯WL=120mm	1PCS
3	胶料	65P PVC黑色低毒 (REACH)	8.8g
2	插头	Φ5.5*2.1*20mm 外沟槽内音叉 内缩1.0mm 铜镀镍 黑色绝缘环	1PCS
1	线材	UL2468 24# (11/0.16AS)*2P黑/黑印白黑线 (REACH)	1540mm
序号	料号	品名	规格 描述 用量

RevNO	Revision note	Date	Signature	Checked	ECN NO.

Unit: mm  
Dim Tolerances:  
0°: ±0.1  
°6: ±0.2  
°15: ±0.3  
°25: ±0.5  
25°: ±1.0  
Angle: ±0.5°

**SHENZHEN HONOR ELECTRONICS CO., LTD.**

Model ADS-12FG

Modification	Name	Date	Part Name	DC CABLE
Designed by	刘志华	17.09.02	Part NO	33003411024P
Checked by			DWG NO	KPJW-08
Approved by			Rev	A/0 Scale 1:1

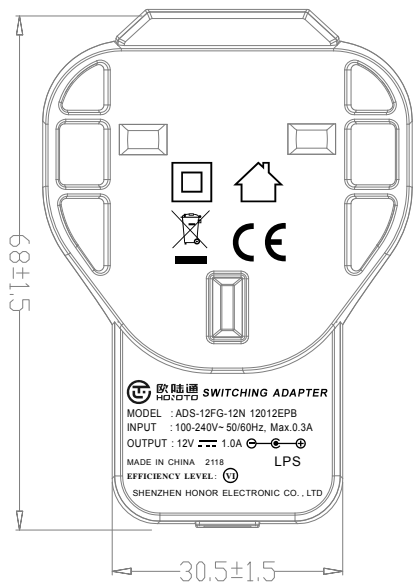

1 : 1

 欧陆通 SWITCHING ADAPTER  
 HONOTO  
 MODEL : ADS-12FG-12N 12012EPB  
 INPUT : 100-240V~50/60Hz, Max.0.3A  
 OUTPUT : 12V  $\overline{\text{---}}$  1.0A  $\text{---}$   $\text{---}$   
 MADE IN CHINA 2118 LPS  
 EFFICIENCY LEVEL: VI  
 SHENZHEN HONOR ELECTRONIC CO., LTD

15.50 mm

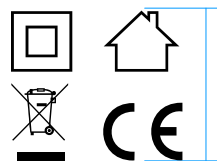

13.50 mm

2118

日期码, 随着周期变化  
 "21"表示生产周, "18"表示生产年

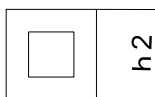
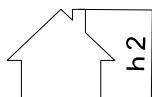

h1>5mm, 长宽按比例缩放

h2>5mm, 长宽按比例缩放

标贴要求: 镭射

TOLERANCES UNLESS NOTED OTHER WISE	MATERIAL			DRAWING NAME	LABEL, DESIGNATION		
	FINISH			MODEL NO.			
X. :+0/-0.2	DESIGNER	梁超	18.05.26	SIZE	DRAWING NO.		REV.
XX. :+0/-0.2	CHECK			A4			A
XXX. :+0/-0.3	APPROVAL						
ANGLE:±2°		UNIT mm		SCALE N /S		SHEET 1 OF 1	

5-4. Barcode Drawing



← 条码类别: 128

海康料号: 101701323  
(扫描内容不显示海康料号)

中间空一格  
(海康料号与供方代码之间)

供方代码, 欧陆通(H)

海康料号: 101701323,  
条形码中只取最后三位“323”

产品版本代码(如初始版本A0, 第二次更改为: A1)

机台流水号(00001~99999)

生产年, 月, 日代码  
年: 1位(1~9)如: 2016=6, 2017=7, , ,  
月: 1位(1~9, 10=A, 11=B, 12=C)  
日: 1位(1~9, A~X) I, 0除外

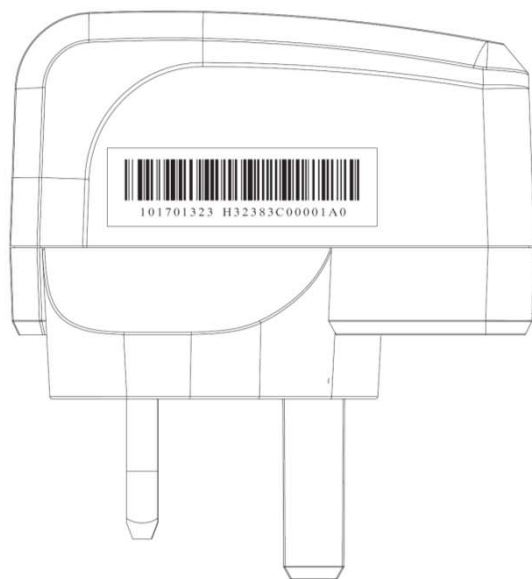



**5-5. Packing Drawing**

**备注:**

- 1、材质：外箱:A=A<sub>1</sub>, 五层瓦楞纸, 厚度: 5.0mm Min. (外箱材质可根据订单而改变)
- 2、外观：光洁, 无污点, 黄白色且无色差, 交接处无裂缝。
- 3、尺寸：外箱尺寸为箱内尺寸, 公差为±5mm。
- 4、数量：100PCS, (1层装20PCS) 分5层装。
- 5、需先送样承认OK之后方可进料

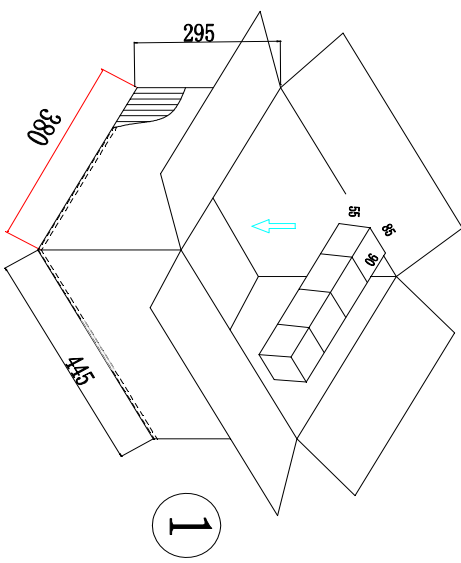

**1**

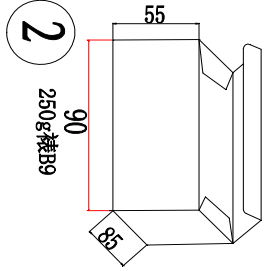

**2**

尺寸为白盒外尺寸

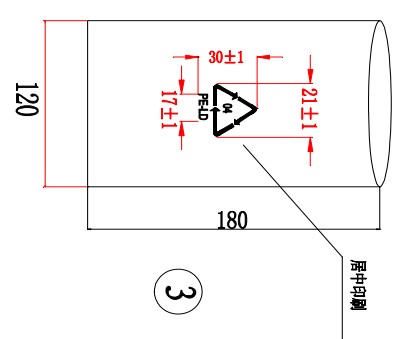

**3**

NO.	Part NO.	Name	Specification	QTY	Unit
3	17912018001R	PE袋	120*180*0.04	1	PCS
2		白盒	90*85*55MM	1	PCS
1		外箱	445*380*295MM A=A <sub>1</sub>	0.01	PCS

**公差(单位/MM):**

1. 刀卡: ±2
2. 外箱: ±5
3. PE袋厚: ±0.005
4. 白盒: ±3
5. 其它参照图面



**SHENZHEN HONOR ELECTRONIC CO., LTD**

RevNO	Revision note	Date	Signature	Checked	ECN NO.

Model	Name	Date	Part Name
ADS-12FG-白盒包装	郝小耀	2018-11.13	包材组件
Modification	Checked by	Part NO	包材组件
Designed by	Checked by	DWG NO	
Approved by	Rev	A/0	Scale